

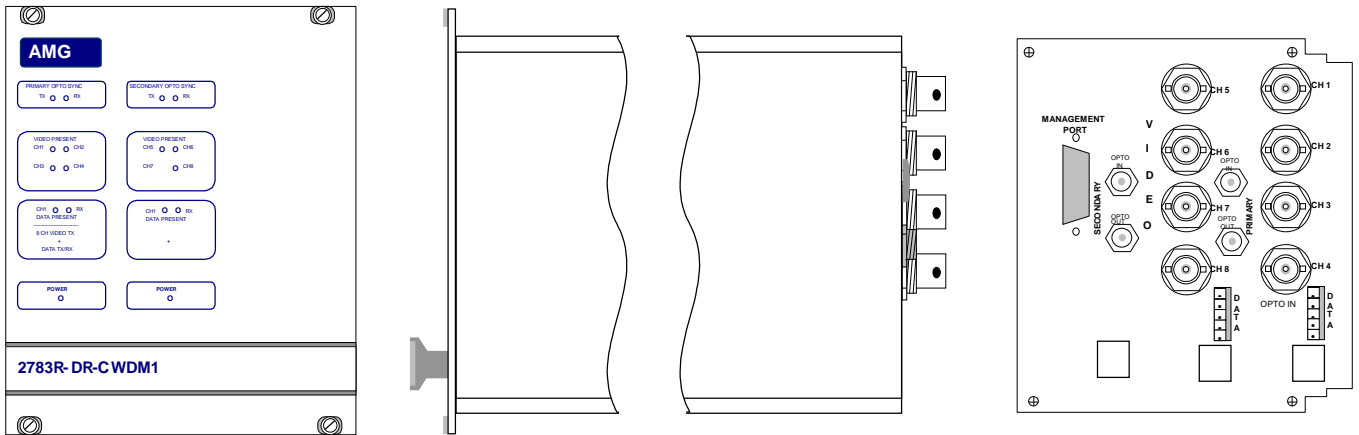

# AMG2783R-DR-CWDMn Instruction Manual

## *Eight Channel Video Transmit Unit with Bi-directional Data with Dual Redundant Operation on a dual fibre ring*



**AMG2783R-DR-CWDMn** is a rackmount eight channel video transmit unit designed to transmit eight video signals onto a dual fibre optical fibre ring. It also provides a RS485/RS422 bi-directional data channel to the video receiver. The **AMG2783R-DR-CWDMn** is designed to plug into an **AMG2000** or an **AMG2005** subrack which in turn fits into a 19" rack system.

The **AMG2783R-DR-CWDMn** is designed to operate with an **AMG2784-DR-CWDMn** 8 channel video and bi-directional data receive unit or their rackmount equivalents.

<b>Index</b>	<b>Page No.</b>
<b>Introduction</b> .....	<b>2</b>
Unit Functional Schematic.....	2
Optical System Connection .....	2
<b>Connections</b> .....	<b>3</b>
Video Input Connections .....	3
Optical Connections .....	3
Power Connections .....	4
Data Connections.....	4
<b>Indicators</b> .....	<b>5</b>
<b>Physical Information</b> .....	<b>6</b>
Dimensions.....	6
Mounting Details.....	6
<b>Configuration of the Data Channel</b> .....	<b>6</b>
<b>SW1 Switch Settings</b> .....	<b>7</b>
<b>Removal from the Case</b> .....	<b>8</b>
<b>Safety</b> .....	<b>8</b>
<b>Maintenance and Repair</b> .....	<b>8</b>

## Introduction

### Unit Functional Schematic

The **AMG2783R DR-CWDM<sub>n</sub>** receives a CWDM wavelength 'n' optical signal from both a primary and secondary fibre input. It inserts up to 8 video signals and data onto the optical fibre and receives a two data channel signals transmitted from **AMG2784R-DR-CWDM<sub>n</sub>** receiver.

In normal operation the data signal is taken from the primary input and the video and data transmitted out on the primary output. The secondary optical input is independent and is regenerated on the secondary output.

If the primary input signal is not present, the unit will shut down the secondary output to inform the previous unit that the signal route is not OK. The previous unit will then send out the data signal on its secondary output. This signal will be repeated around the ring to get back to this **AMG2783R-DR-CWDM<sub>n</sub>**. on the secondary route. As the primary input is not present on this unit, the data signal will now be taken from the secondary optical input. Thus maintaining integrity of the video and data transmission.

If the secondary input signal is not present, the unit will assume that the route to the next unit is not OK and send out the video and data signal on the secondary optical output. This return video and data signal will be transmitted to the next unit around the ring in the opposite direction on the secondary route.

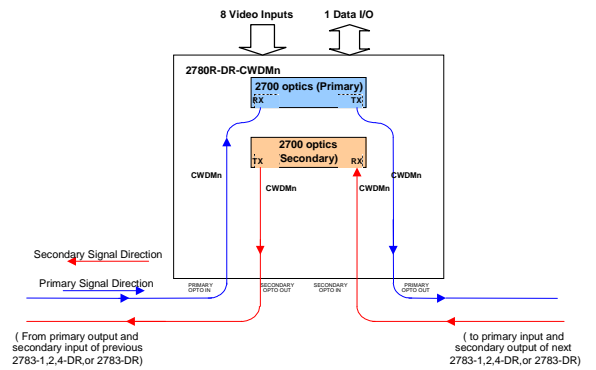

### Optical System Connection

The **AMG2783R-DR-CWDM<sub>n</sub>** units are designed to be connected in a point to point system with an **AMG2784R-DR-CWDM<sub>n</sub>**. The optical dynamic range between each optically connected node is 22dB.

Note that where necessary repeaters can be added to increase transmission distances.

The **AMG2784R-DR-CWDM<sub>n</sub>** is connected as illustrated below when used with an **AMG2783R-DR-CWDM<sub>n</sub>** 8 channel insert unit.

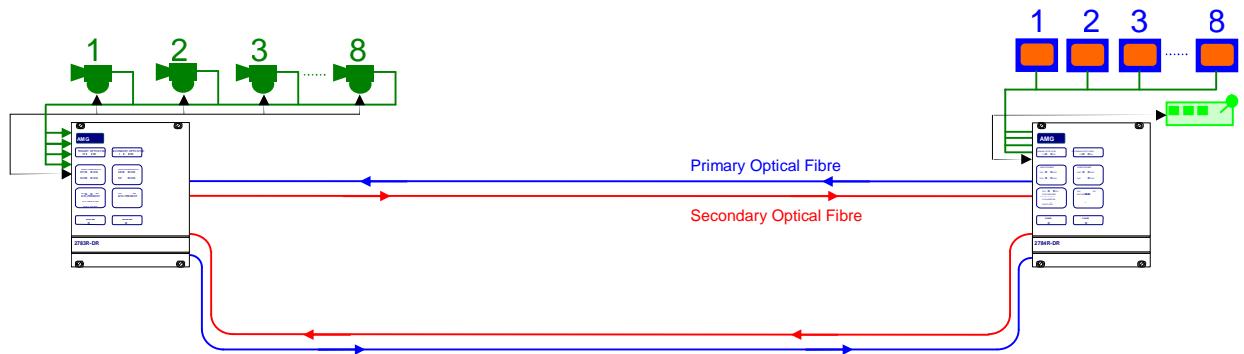

If one of the routes is broken, operation of the system is maintained as shown below:

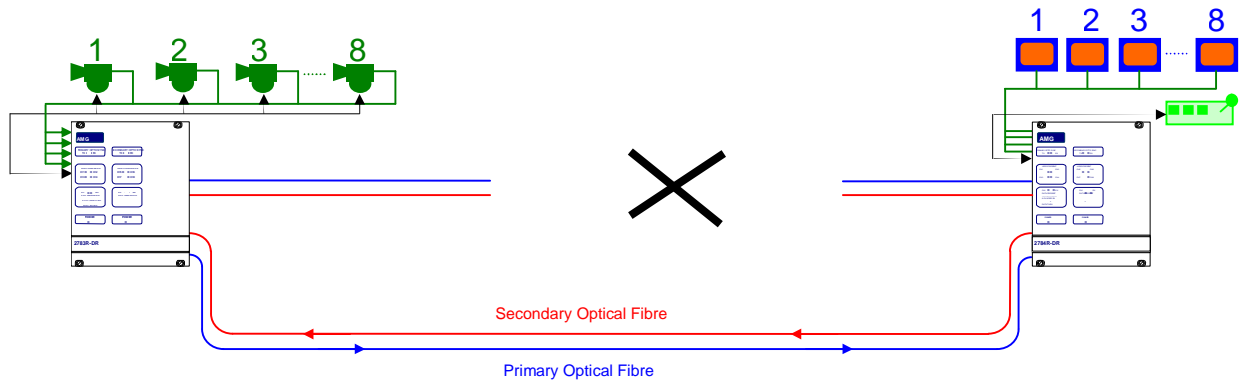

Or:

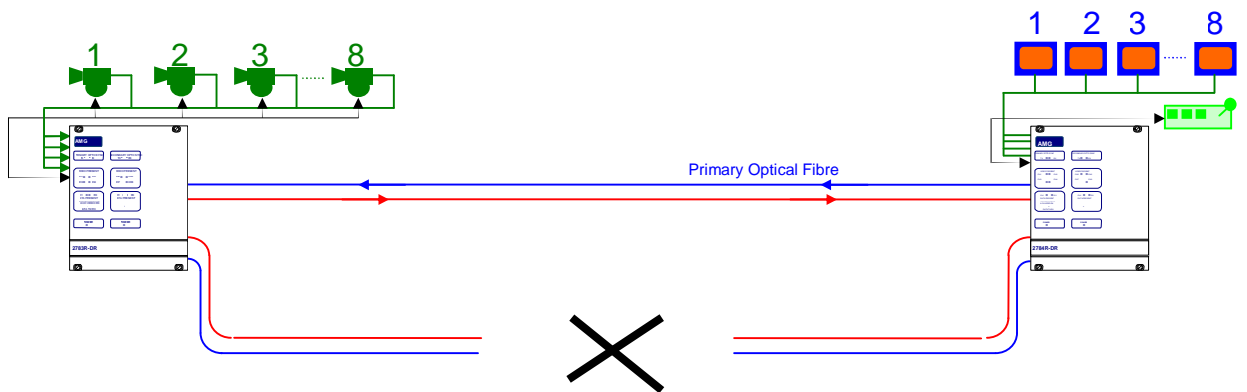

## Connections

### Video Input Connections

Connector .....	75 ohm BNC Socket.
Input Impedance .....	75 ohm terminated.
Input Level .....	1 volt p-p nominal
Frequency Response .....	10Hz to 5.75MHz min.
No of channels .....	8

### Optical Connections

#### PRIMARY OPTO OUT

Connector .....	FC/PC
Primary Channel Launch Power .....	-3dBm

#### PRIMARY OPTO IN

Connector .....	FC/PC
Primary Channel Sensitivity .....	-25dBm

#### SECONDARY OPTO OUT

Connector .....	FC/PC
Secondary Channel Launch Power .....	-3dBm

**SECONDARY OPTO IN**

Secondary Channel Sensitivity .....-25dBm

Operating Wavelength .....n = 1 1510nm  
 n = 2 1530nm  
 n = 3 1550nm  
 n = 4 1570nm  
 n = 5 1470nm  
 n = 6 1490nm  
 n = 7 1590nm  
 n = 8 1610nm

**Power Connection**

Power supply ..... from plug in connection on the 2000 or 2005 subrack  
 Power consumption .....20 Watts max.

**Data Connections**

Number of Channels..... Two independent data channels, one associated with video channels 1-4 and another associated with video channels 5-8.

Data Connector ..... 5 way removable spring terminal connector (2.5mm spacing)  
 Manufacturers Part No. Phoenix/Combicom FK-MC-0.5/5-ST-2.5  
 AMG Part No G15098-00

SW1 used to select between RS232 and RS485/422, SW2 is used to select between RS422 and RS485.

**NOTE: The unit is shipped from the factory as RS485 unless otherwise requested.**

Connections RS422 4 wire ..... See schematic

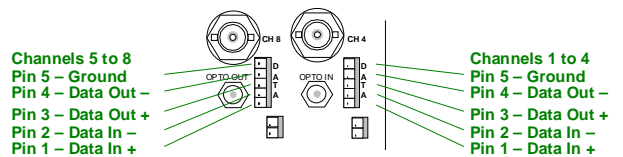

Connections RS485 4 wire ..... See schematic

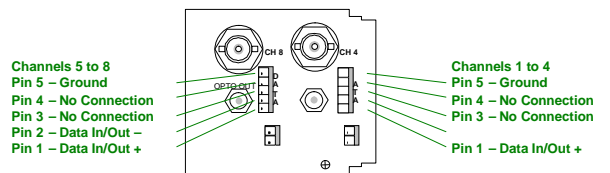

Connections RS232 ..... See schematic

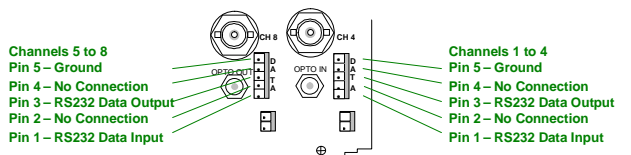

Protocol..... RS232  
 SW1 switch position 9 on, switch position 10 on  
 SW2 all off

RS485 2wire  
 SW1 switch position 9 off, switch position 10 off  
 SW2 see below

RS422 4 wire Bus'ed or point to point  
 SW1 switch position 9 off, switch position 10 off  
 SW2 see below

See below for **Configuration of the RS485 / RS422 data channel** and description of tristate operation

Each of the two data channels can be set up independently.

**Indicators**

Power.....	Green	– unit powered
	Off	– no power applied to unit
Primary Opto Sync TX.....	Green	- optical channel transmitting
	Off	- optical channel not transmitting
Primary Opto Sync RX.....	Green	- optical channel receiving
	Off	- optical channel not receiving
Secondary Opto Sync TX.....	Green	- optical channel transmitting
	Off	- optical channel not transmitting
Secondary Opto Sync RX.....	Green	- optical channel receiving
	Off	- optical channel not receiving
Video Present CH1-8.....	Green	– video signal present on video channel BNC
	Off	– no video present on video channel BNC
Data Present TX.....	Green	– logic one present on the data input
	Red	– logic zero present on the data input
	Off	– tri-state off or no connection on the data input
This represents the data signals being transmitted on the optical fibre		
Data Present RX.....	Green	– logic one present on the corresponding data output
	Red	– logic zero present on the data output
	Off	– tri-state off on the data output
This represents the data signals being received on the optical fibre		

## Physical Information

### Dimensions

Height ..... 3U Plug-in  
Width..... 21HP  
Depth ..... 170mm excluding connectors  
Weight..... 1100grams

### Mounting Details

The unit is designed to be mounted within a 2000 or 2005 Subrack on standard card guides. Note the AMG standard racks are supplied with guide rails every 7HP. In order to fit this unit in the subrack, 2 sets of card guides have to be removed by pulling gently on the card guides.

The 2000 series subrack is fitted with a 50 watt power supply. A maximum of 2 units may be fitted into one 2000 series subrack.

The 2005 series subrack is fitted with a 100 watt power supply. A maximum of 3 units may be fitted into one 2005 series subrack limited by the 70HP rack space.

### Configuration of the Data Channel

SW1 and SW2 determine the protocol of the data channel. This can be RS232, RS485 or RS422. (See below for **removal from the case** and access to SW1 and SW2)

**Mode 1 – RS485 two wire half duplex transmission.**

**Mode 2 – RS422 four wire full duplex transmission.**

In this mode the RS422 output will transmit a tristate condition as well as logic high and logic low for systems which require bus-ing of the RS422 four-wire connection.

MODE	Configuration Details	SW2 position 1	SW2 position 2	SW2 position 3	SW2 position 4	SW1 position 9	SW1 position 10
1	RS-422 4 wire Point-to-Point - and RS-422 BUS system	OFF	OFF	OFF	OFF	OFF	OFF
2	RS-485 2 wire BUS systems	OFF	ON	ON	ON	OFF	OFF

The data input for both the RS485 and the RS422 modes detects a tri-state input condition by monitoring the differential voltage level across the input. A differential level below 500mV positive or negative will be detected as a tristate condition. A level above 500mV positive or negative will be detected as a logic 1 or logic zero respectively. **It is important therefore to terminate the RS485 bus or the RS422 input bus using 120ohms if a pre-bias is present on the RS485 or RS422 bus.** A large number of third party equipment manufacturers apply a pre-bias on their RS485 bus. This pre-bias is applied by pulling one arm of the RS485 bus high (+5 volts) and the other arm low (0 volts) using high value resistors within the third party equipment. In order to ensure that the AMG2700 equipment detects a tri-state condition, then these resistors should have a value above 1kohm.

**Mode 3 – RS232 full duplex transmission.**

MODE	Configuration Details	SW2 position 1	SW2 position 2	SW2 position 3	SW2 position 4	SW1 position 9	SW1 position 10
3	RS-232 Point to Point	OFF	OFF	OFF	OFF	ON	ON

**Note: - the data channel is set at Mode 1 – RS485 operation at the factory unless otherwise requested.**

## SW1 Switch Settings

All SW1 switch settings are set at the factory as follows:

### Channels 1-4 Card

Switch Position	Description	Setting
1	Video channel configuration	OFF
2	Video channel configuration	OFF
3	Video channel configuration	OFF
4	Primary / Secondary Board Setting	ON
5	Dual Redundant / Not dual redundant	OFF
6	Not Used	OFF
7	Not Used	OFF
8	On board data / Separate data card	ON
9	RS232 Select	OFF for RS485/422
10	RS232 Select	OFF for RS485/422

### Channels 5-8 Card

Switch Position	Description	Setting
1	Video channel configuration	OFF
2	Video channel configuration	OFF
3	Video channel configuration	ON
4	Primary / Secondary Board Setting	OFF
5	Dual Redundant / Not dual redundant	OFF
6	Not Used	OFF
7	Not Used	OFF
8	On board data / Separate data card	ON
9	RS232 or RS422/485	OFF for RS485/422
10	RS232 or RS422/485	OFF for RS485/422

## **Removal from the Case**

**Note:** - The 2700 PCB's are static sensitive. Handle with proper care and use normal electrostatic discharge (ESD) procedures. Use properly grounded protection (for example, wrist straps) when handling the PCB.

In order to remove the case (to access SW1 and SW2)

- 1.1. Loosen and remove the four screws on the top and bottom of the unit's rear panel.
- 1.2. Slide the PCB assembly connected to the rear panel out of the case.
- 1.3. Ensure that the optical fibre is not trapped.

SW1 and SW2 can be found on the bottom right hand corner of each board and are labelled, close to the rear panel. The switch position are labelled on the switch, switch position 1 is always the furthest from the edge of the PCB.

When re-inserting the main PCB into the housing take care not to trap the optical fibre or the board interconnection cables.

Fasten the rear panel with the screws.

## **Safety**

The 2700 series of products uses a Class 1 laser system in accordance with EN 60825-2:2000.

It is always advisable to follow good practice when working with optical fibre systems. This includes:

- Do not stare with unprotected eyes or with any unapproved collimating device at fibre ends or connector faces, or point them at other people.
- Use only approved filtered or attenuating viewing aids

For other safety issues and advice on good practice associated with the optical fibres systems see EN 60825-2:2000 or your local safety officer.

## **Maintenance and Repair**

There are no user serviceable parts within the AMG2700 products.

In case of problem or failure contact your local support centre or AMG Systems Ltd, Technical Support Department on tel. +44 (0) 1767 600777.

See unit data sheet for full specification.